

# 980459

1.

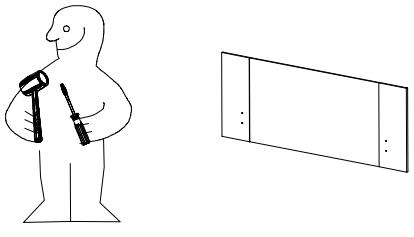

2.

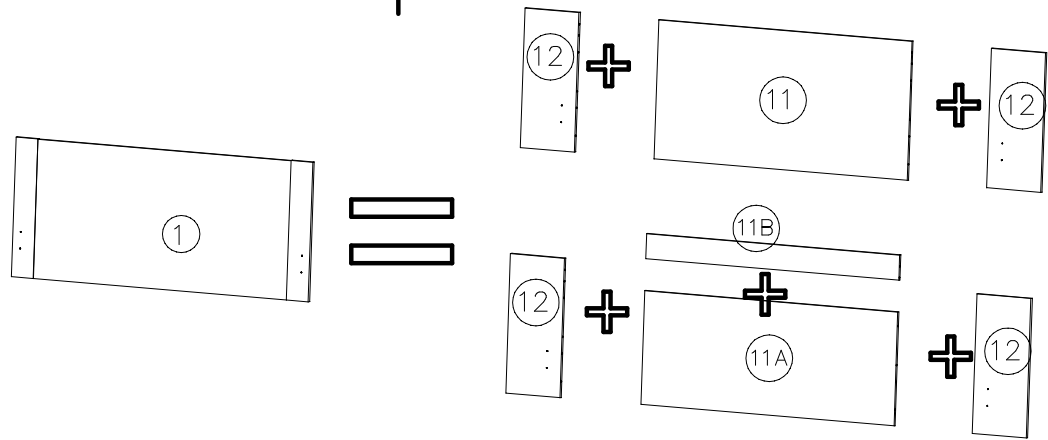
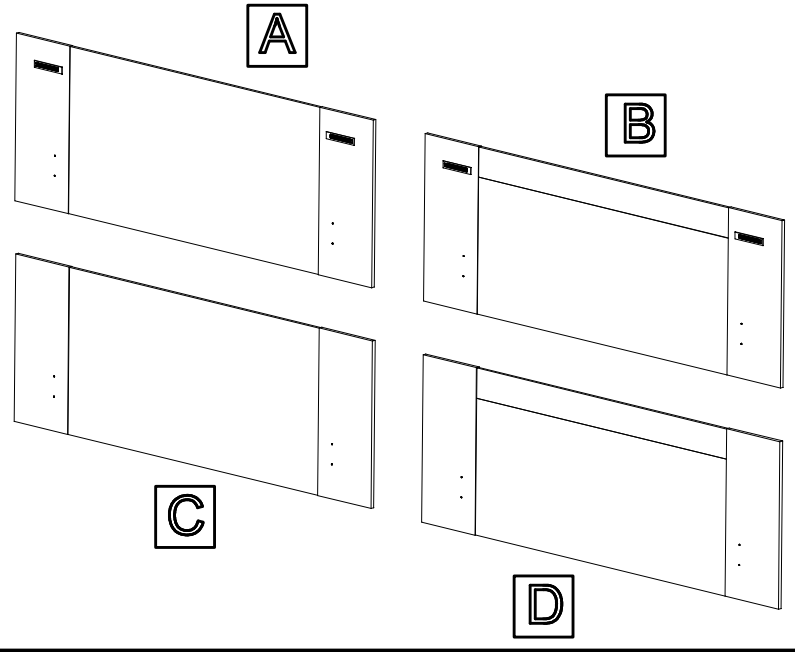
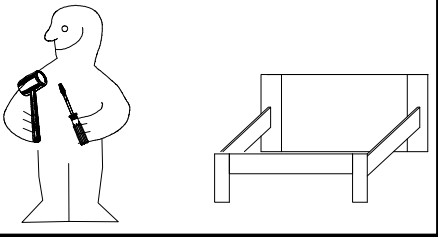

- 163 007 1x
- D1 12x
- 353 007 Ø8 x 4.0 4x
- 114 183 4 x 13mm SP13 16x
- 121 122

- B D
- 4,0 x 15 mm G23 12x
- 121 110 H5 3x
- 114 183
- A B
- 2x LED 177 TR

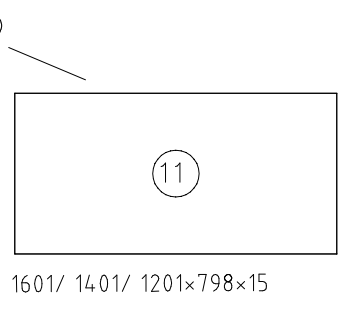
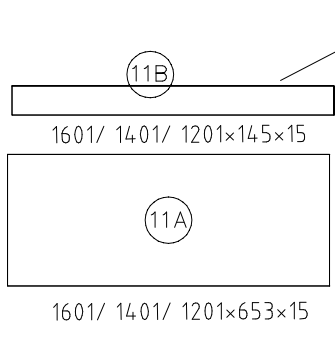
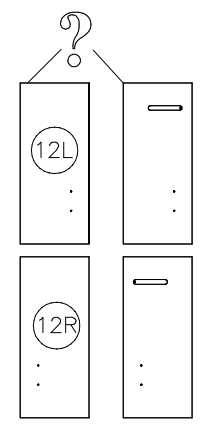

800x341x18

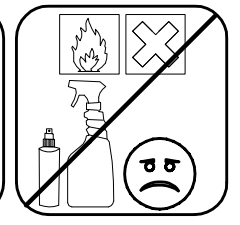
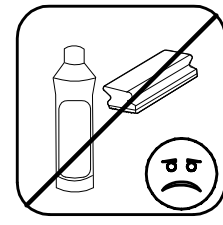
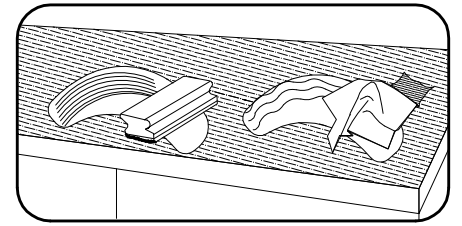
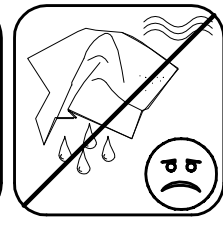
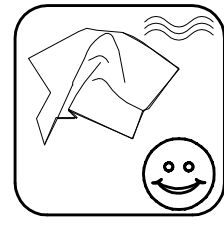
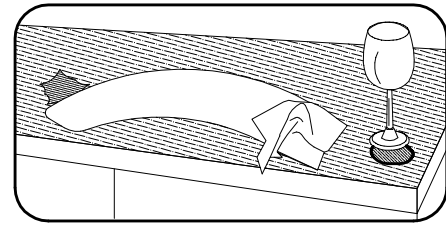
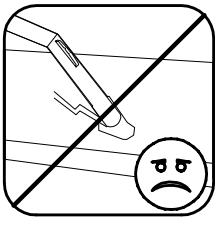
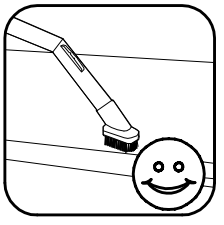
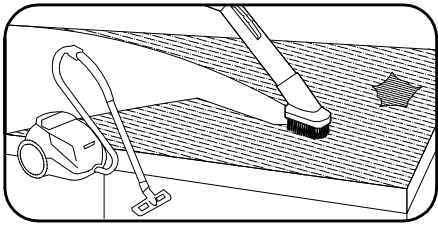

1

BD

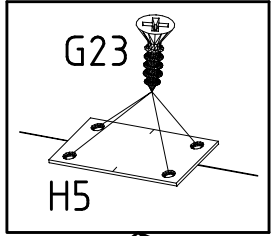
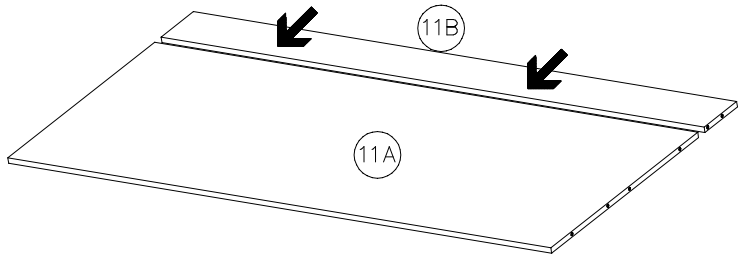

H5

114 183  
4,0 x 15 mm

G23

121 110

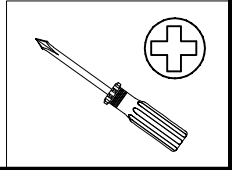
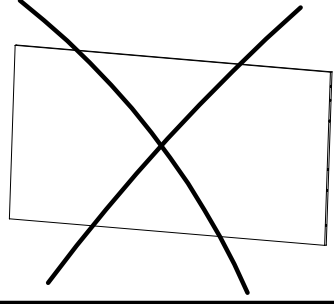
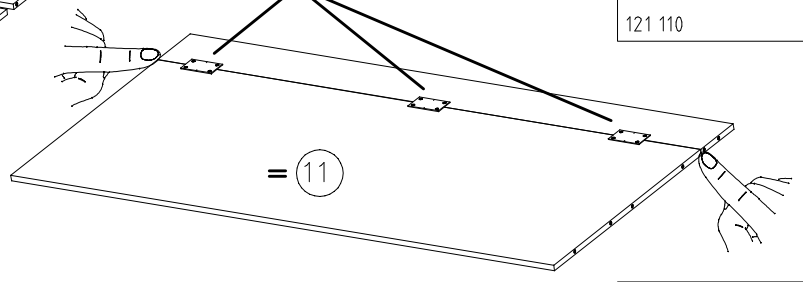

2

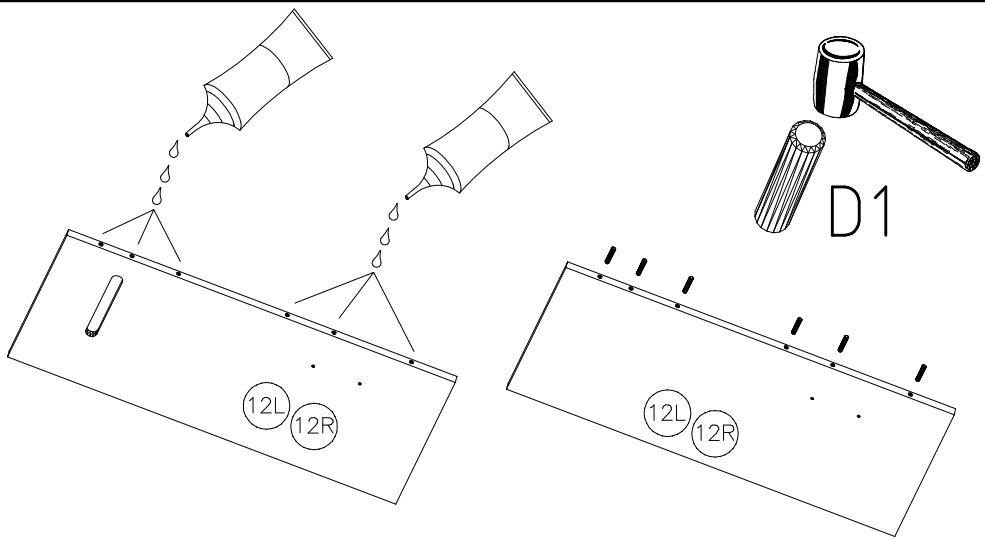

LEIM  
LEIM  
GLUE

163 007

D1

353 007  $\phi 8 \times 40$

3

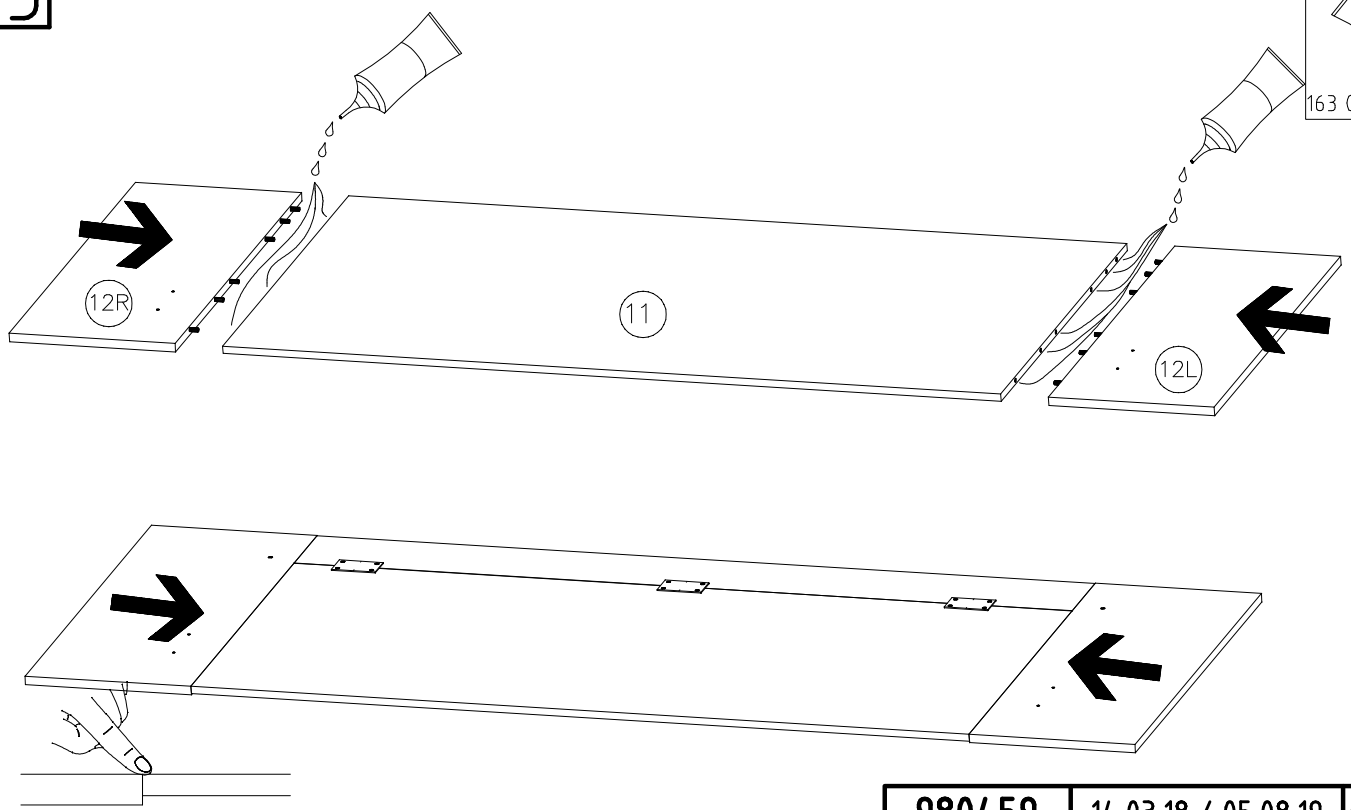

LEIM  
LEIM  
GLUE

163 007

4

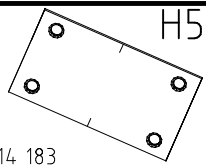
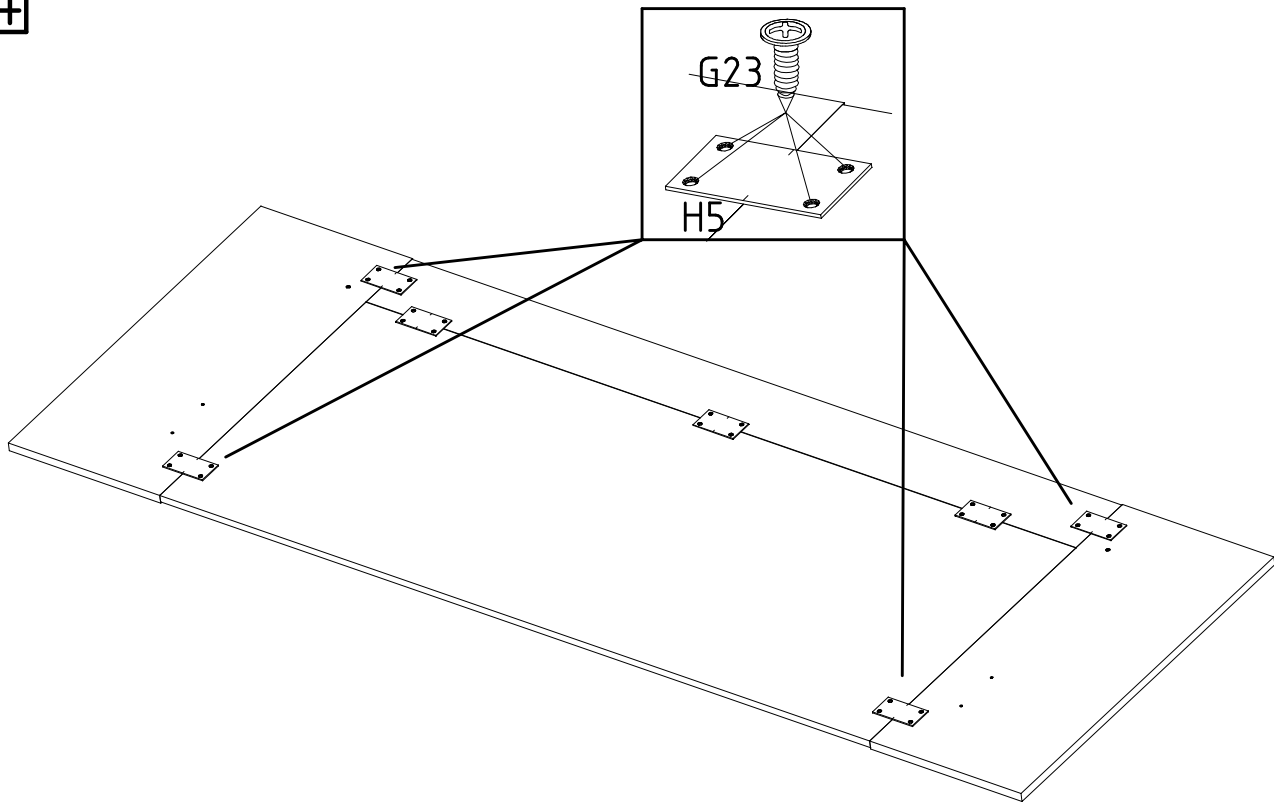

114 183

SP13

4 X 13mm

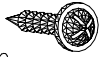

121 122

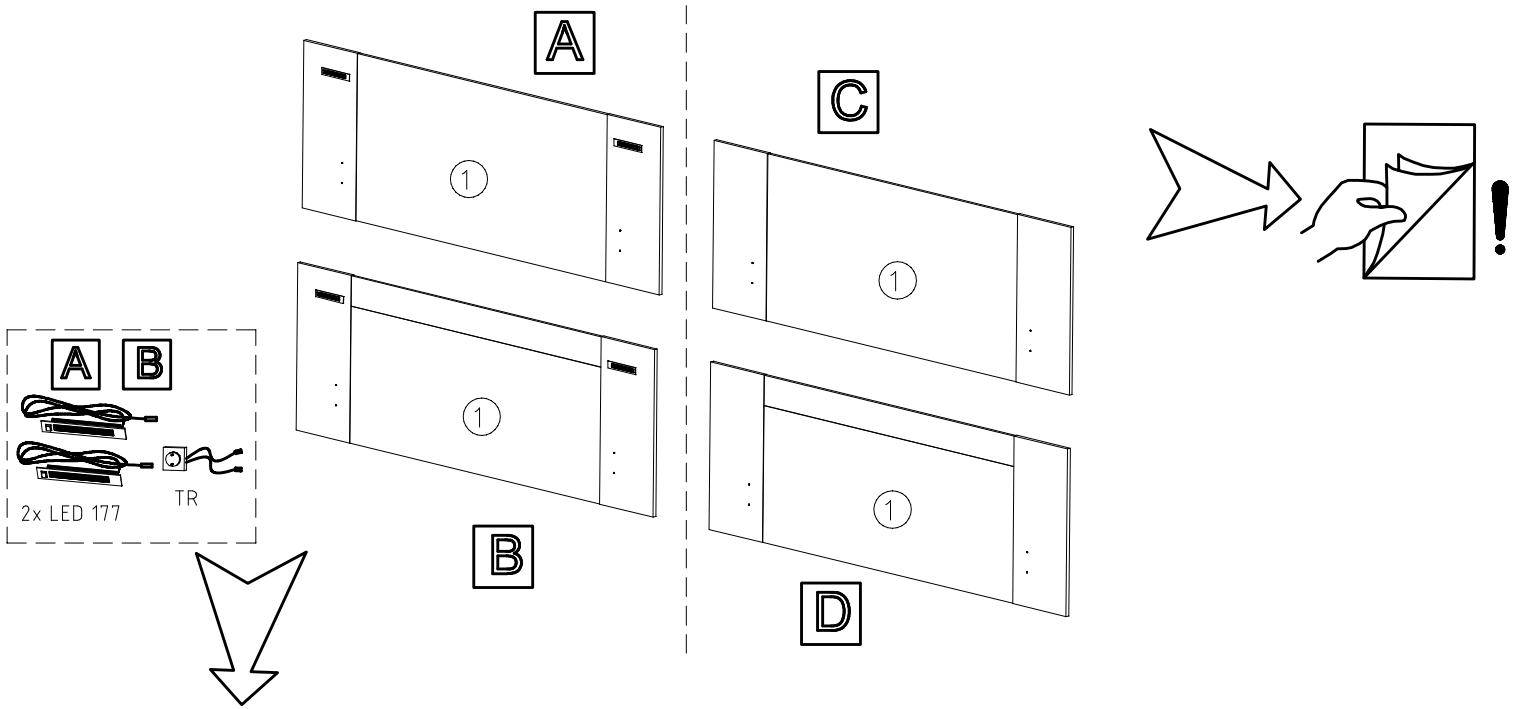
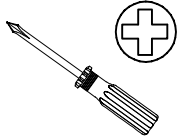

5

LED177

LED177

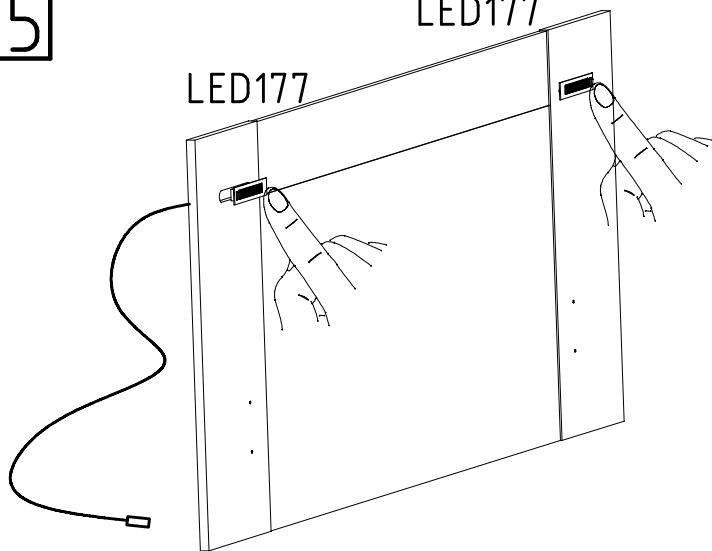

LED177

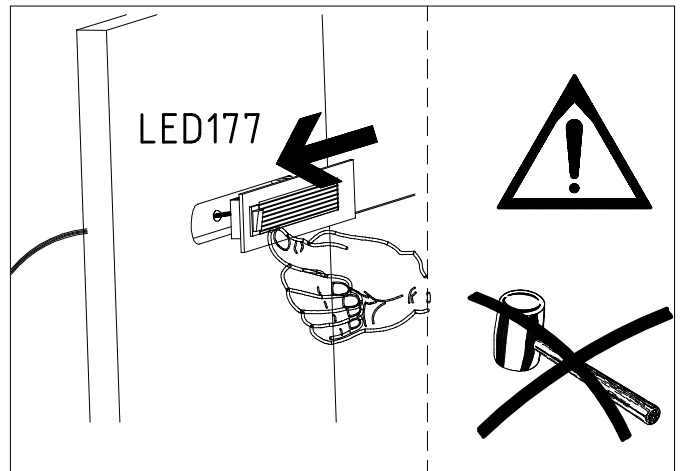

980459

14.03.18 / 05.08.19

08 19

3/4

6

